



AA IMPACT

GARAGE DOOR



WELCOME

Thankyou forchoosing AAImpact GarageDoor

AA Impact Garage Door is a family-owned and operated company based in Miami, Florida. We design and build impact glass garage doors that deliver the perfect balance of strength, style, and reliability.

Every product we

make is engineered to meet the highest hurricane protection standards while enhancing the look and value of any property.

Our guiding principle is simple:

“Built to last and designed to impress.”

That means doors that stand up to the toughest conditions and look great doing it.

We work with top-grade materials and precise manufacturing processes to ensure every detail is right from reinforced frames and smooth-rolling hardware to premium powder-coated finishes. The result is a door that delivers on every level, year after year.

As a family-owned business, we take pride in building long-term relationships with our dealers, contractors, and installers. We believe success comes from delivering great products, being easy to work with, and always standing behind what we sell.



We Manufacture Impact Glass Garage Doors

At A A Impact Garage door, we specialize in crafting the most durable and aesthetic glass garage doors, featuring industry leading hurricane resistance. Engineered to endure the toughest conditions, our doors seamlessly combine strength and elegance to enhance any home or business.



WHY SHOULD YOU USE OUR PRODUCT?



HURRICANE PROTECTION

Provides superior protection against hurricanes and extreme weather conditions, ensuring the safety of your home and family.



SECURITY

Enhanced security features for peace of mind, protecting your home against forced entry and intruders.



ENERGY EFFICIENCY

Designed to improve energy efficiency, reducing utility costs by maintaining a comfortable temperature inside your home.



NOISE REDUCTION

Minimizes external noise, creating a quieter and more peaceful indoor environment.



UV PROTECTION

Blocks harmful UV rays, preserving your furniture, flooring, and belongings from sun damage.



INSURANCE PREMIUM DISCOUNTS

May qualify for insurance premium discounts, providing additional cost savings for homeowners.



INCREASED PROPERTY VALUE

Adds value to your property with durable, high-quality impact garage doors.



BECOME A DEALER

Take the next step and apply here
<https://aaimpactgaragedoor.com/become-a-dealer>



AAImpactgaragedoor



OUR WEBSITE
www.AAImpactGarageDoor.com



CONTACT US
(info@aaidg.com)

DOOR FEATURES

(STRENGTH)

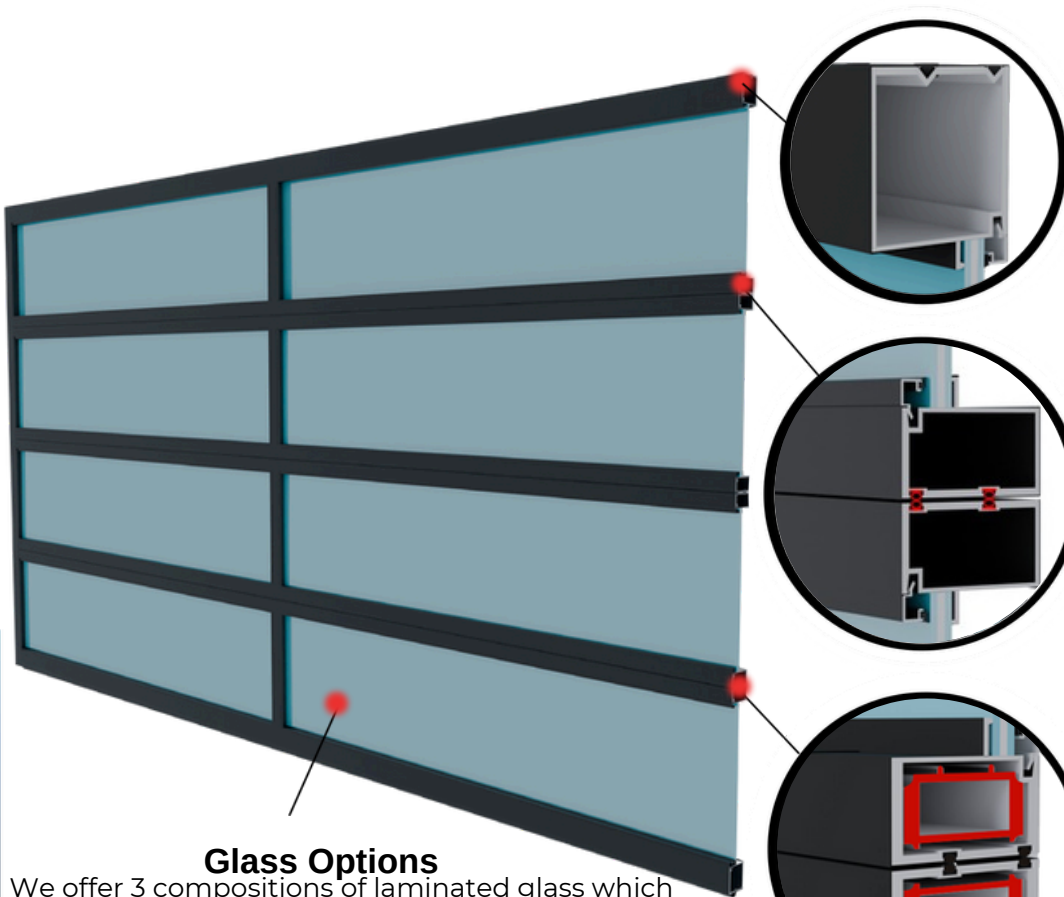

Glass Options

We offer 3 compositions of laminated glass which consist of 5/16", 7/16" or 13/16" Insulated laminated glass

3" Thick Door

3" Thick Garage Door built for maximum durability and security. Designed for both commercial and residential applications, it offers superior resistance to impact and extreme hurricane conditions, ensuring long-lasting performance and protection.

Double Gasket Seal

Designed to eliminate air and water infiltration, keeping your home or business protected from unwanted elements.

Concealed Reinforcement

Engineered to reinforce doors to withstand up to +89/-106 design pressures, per certified engineer calculations. Required on doors wider than 16'2" or to increase the design pressures on any size door.

3" Tracks / 3" Rollers

Impact glass garage doors can weigh three to four times more than a standard door, which is why we use heavy-duty 3" tracks eliminating the risk of door roll-off and ensuring smoother, more reliable operation.

Double Hinge Roller Carriers

Heavy-duty doors require more than just strong panels they need strong hardware too. Our design uses double hinge roller carriers, placing two 11-gauge steel hinges at each roller instead of the industry standard of just one. This setup spreads the weight load across both hinges, reducing stress, improving durability, and ensuring smooth, safe operation for the long haul.

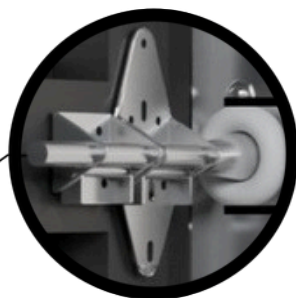
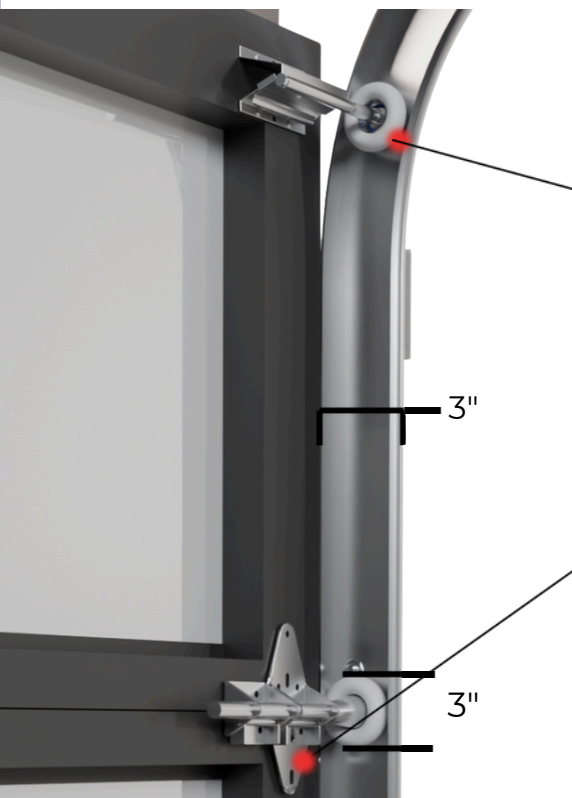

DOOR FEATURES

(BEAUTY)

Extrusion End Caps

Extrusion end caps seal off open cavities in the door frame, reducing noise and air leakage for improved energy efficiency and sound insulation.

They also enhance the appearance of the door by hiding exposed extrusions, preventing the unsightly view into the internal structure resulting in a cleaner, more refined finish.

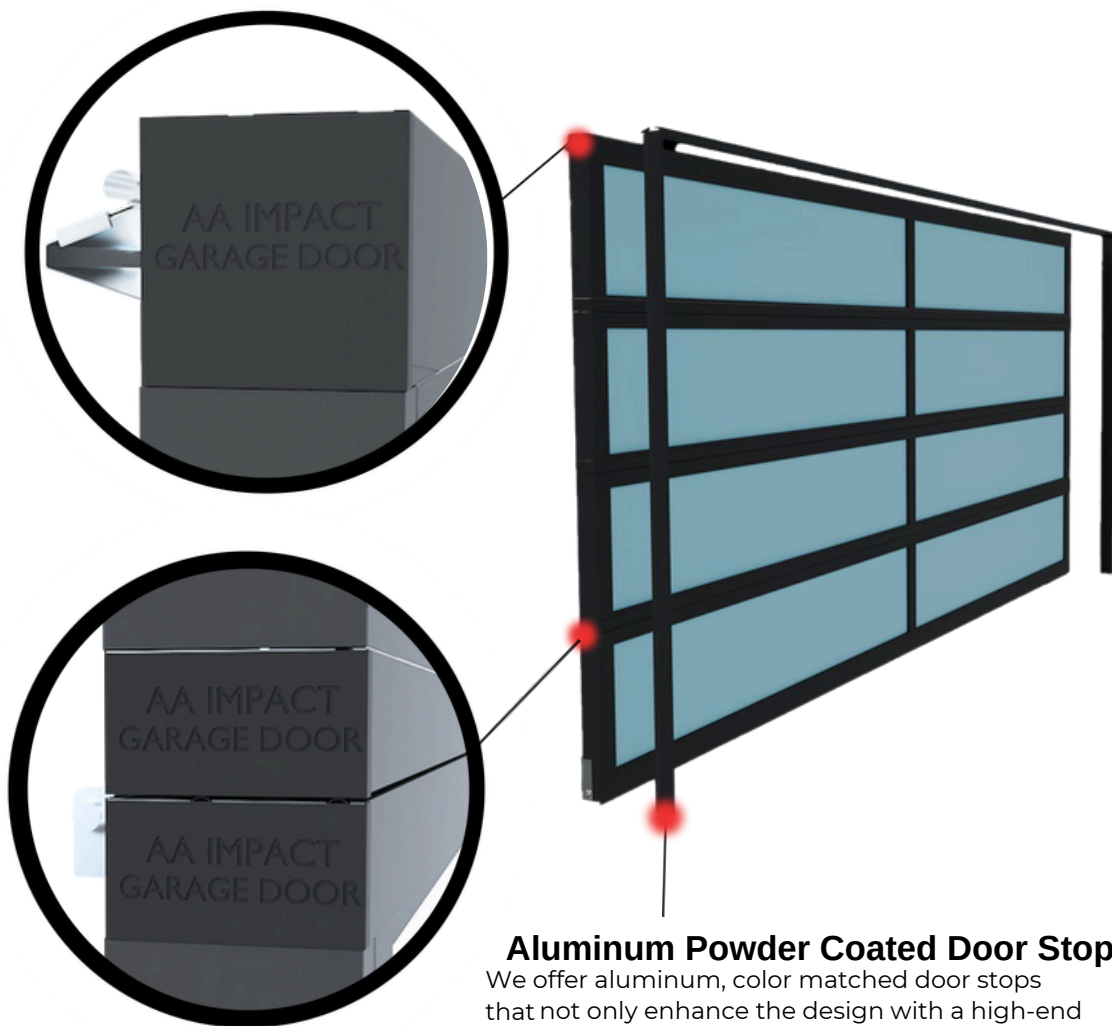

Aluminum Powder Coated Door Stops

We offer aluminum, color matched door stops that not only enhance the design with a high-end premium finish but also last up to 10 times longer than standard door stops.



TOP RAIL

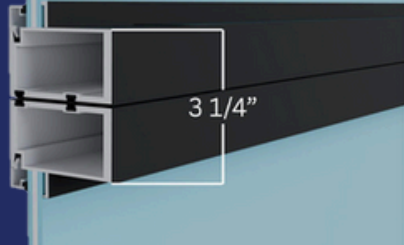

INTERMEDIATES



BOTTOM RAIL

Sleek Extrusion Design, delivering a clean, modern look without the bulky, cluttered appearance of double stiles used by competitors. While others sacrifice aesthetics for structure, our engineering ensures maximum strength and durability while maintaining a seamless, high end design perfect for both commercial and residential applications.



AAImpactgaragedoor



OUR WEBSITE
www.AAImpactGarageDoor.com



CONTACT US
(info@aaigd.com)

CUSTOM OPTIONS

CHOOSE YOUR GARAGE DOOR

STEP 01

DOOR CONFIGURATIONS

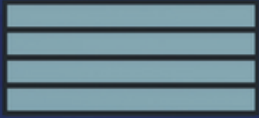

1 LITES

(Standard option for doors up to 12' wide)

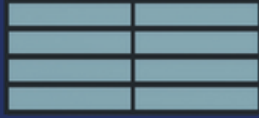

2 LITES

(Standard option for doors larger than 12' wide)

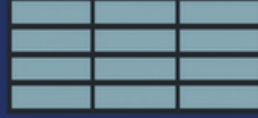

3 LITES

(Custom options for doors larger than 12' wide)



4 LITES

STEP 02

GLASS COLOR



Clear



Bronze



Grey



Double Grey

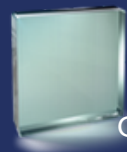

Green

*All glass tint available in low-e

GLASS INTERLAYER



CLEAR

(See Through)



GRAY

(See Through)

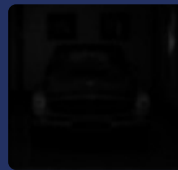

BLACK

(Privacy)

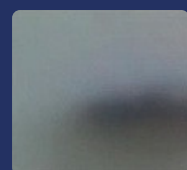

WHITE

(Privacy)

STEP 03

FRAME COLOR

Bronze

White

Black

Silver

Wood Grain
Walnut

Wood Grain
Java

Actual colors may vary slightly due to fluctuations in the printing process. Ask your AA Impact distributor for color samples.



AAImpactgaragedoor



OUR WEBSITE
www.AAImpactGarageDoor.com



CONTACT US
(info@aaigd.com)



AA IMPACT
GARAGE DOOR

SERIES 1200

(Single Lite)

(Series Max Width. 12' wide)



- Meets FL Building code for high velocity hurricane zone large missile rated.
- Sturdy 3" thick frame.
- Compatible with low headroom, standard and high-lift track.
- 3" track and rollers.
- Max design pressure of +50.0/-60.0 PSF.
Design pressure per engineers comparative analysis.
(12' With reinforcement +72/-87 PSF)
(12' W/O reinforcement +63/-76 PSF)
(10' With reinforcement +89/-106 PSF)
(10' W/O reinforcement +78/-93 PSF)
- Glazing capabilities:
(5/16" HS Laminated)
(7/16" HS Laminated)
(13/16" HS Insulated Laminated)
- Powder coating aluminum finish for superb quality environmentally friendly operation.
- Meets AAMA 2604 exigencies (5-year warranty).
- AAMA 2605 is also available (10-year warranty).
- Max Dimensions: 12'0" x 16'3 5/8" .

Florida Product Approval:
FL #46870.1



AAImpactgaragedoor



OUR WEBSITE
www.AAImpactGarageDoor.com



CONTACT US
(info@aaigd.com)



AA IMPACT
GARAGE DOOR

SERIES 1600
(Two Lite Minimum)
(Series Width 12' 1" - 16' 2")



- Meets FL Building code for high-velocity hurricane zone large missile rated.
- Sturdy 3" thick frame.
- Compatible with low headroom, standard and high-lift track.
- 3" track and rollers.
- Max design pressure of +46.0/-55.0 PSF.
Max design pressure with reinforcement +50/-60 PSF
- Glazing capabilities:
 - (5/16" HS Laminated)
 - (7/16" HS Laminated)
 - (13/16" HS Insulated Laminated)
- Powder coating aluminum finish for superb quality environmentally friendly operation.
- Meets AAMA 2604 exigencies (5 year warranty).
- AAMA 2605 is also available (10 year warranty).
- Max dimension of 16'2" x 16'3 5/8" .

Florida Product Approval:
FL #46870.2



AAImpactgaragedoor



OUR WEBSITE
www.AAImpactGarageDoor.com



CONTACT US
(info@aaigd.com)



AA IMPACT
GARAGE DOOR

SERIES 1800

(Two Lite Minimum)
(Series Width 16' 3" - 18' 4")



- Meets FL Building code for high-velocity hurricane zone large missile rated.
- Sturdy 3" thick frame.
- Compatible with low headroom, standard and high-lift track.
- 3" track and rollers.
- Max design pressure of +46.0/-55.0 PSF
- Glazing capabilities:
 - (5/16" HS Laminated)
 - (7/16" HS Laminated)
 - (13/16" HS Insulated Laminated)
- Powder coating aluminum finish for superb quality environmentally friendly operation.
- Meets AAMA 2604 exigencies (5 year warranty).
- AAMA 2605 is also available (10 year warranty)
- Max dimension of 18'4" x 16'3 5/8" .

Florida Product Approval:
FL #46870.3



AAImpactgaragedoor



OUR WEBSITE
www.AAImpactGarageDoor.com



CONTACT US
(info@aaigd.com)



AA IMPACT

GARAGE DOOR



AAImpactgaragedoor



OUR WEBSITE
www.AAImpactGarageDoor.com



CONTACT US
(info@aaigd.com)



AA IMPACT

GARAGE DOOR



AAImpactgaragedoor



OUR WEBSITE
www.AAImpactGarageDoor.com



CONTACT US
(info@aaigd.com)



AA IMPACT

GARAGE DOOR



AFTER

BEFORE



AAImpactgaragedoor



OUR WEBSITE
www.AAImpactGarageDoor.com



CONTACT US
(info@aaigd.com)

Trims/Covers

At our company, we offer high-quality garage door cover trims in both durable plastic and strong metal options to suit a variety of needs and styles. Our plastic trims provide a lightweight, cost-effective solution that resists moisture and corrosion, while our metal trims deliver superior strength and a sleek, long-lasting finish. Whether you're looking for affordability, durability, or a polished appearance, our selection ensures the perfect trim to enhance and protect your garage door installation.

PLASTIC



METAL

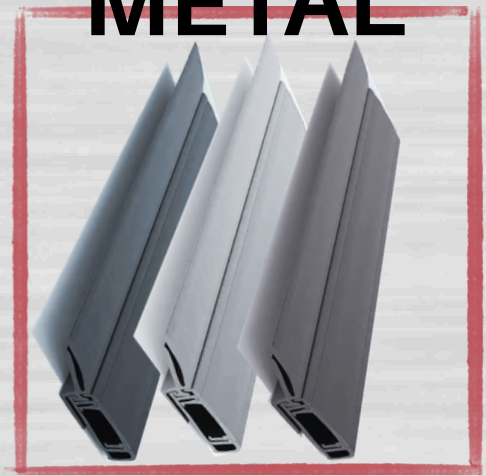

Powder Coated Hardware

We also offer the option to powder coat our hardware, giving your garage door installation a clean, premium finish that elevates the overall look.

Powder coating not only enhances the aesthetics with a smooth, uniform color but also adds an extra layer of durability and resistance to wear, rust, and weather. It's the perfect way to match your hardware to your design and take the final appearance to the next level.

End Caps

Our end caps are designed to provide the perfect finishing touch to your garage door trim system. They create a clean, polished look by neatly covering exposed edges while also helping protect the trim from moisture and debris.



AAImpactgaragedoor



OUR WEBSITE
www.AAImpactGarageDoor.com



CONTACT US
(info@aaigd.com)



AA IMPACT

GARAGE DOOR

BUILT TO LAST AND DESIGNED TO IMPRESS